	<b>TECHNICAL SPECIFICATION</b>	No. <b>I-ET-3000.00-1500-29B-PAZ-006</b>
	CLIENT: <b>E&amp;P</b>	SHEET <b>1 of 28</b>
	JOB: <b>UMBILICAL SYSTEMS FOR SUBSEA APPLICATION</b>	-
	AREA: <b>OFFSHORE BASINS - BRAZIL</b>	
SUB/ES/DCT	TITLE: <b>QUALIFICATION FOR POWER, CONTROL AND INJECTION UMBILICALS</b>	<b>NP-1</b> <b>SUB/ES/DCT</b>

### INDEX OF REVISIONS

REV.	DESCRIPTION AND/OR REVISED SHEETS
0	Original
A	All pages, including document title
B	General revision

	REV. 0	REV. A	REV. B	REV. C	REV. D	REV. E	REV. F	REV. G	REV. H
DATE	SEP/2010	MAY/2014	JUN/2017						
DESIGN	IPP/ES	IPP/ES	SUB/ES/DCT						
EXECUTION	FBA	BF6S	BF6S						
CHECK	YR / AAG	CSMP / CJME	CSMP						
APPROVAL	CASP	LPH6	JGLV						

INFORMATION IN THIS DOCUMENT IS PROPERTY OF PETROBRAS, BEING PROHIBITED OUTSIDE OF THEIR PURPOSE

FORM OWNED TO PETROBRAS N-0381 REV. L

	TECHNICAL SPECIFICATION	No. I-ET-3000.00-1500-29B-PAZ-006	REV. B
	UMBILICAL SYSTEMS FOR SUBSEA APPLICATION		SHEET 2 of 28
	TITLE: QUALIFICATION FOR POWER, CONTROL AND INJECTION UMBILICALS		NP-1
			SUB/ES/DCT

## INDEX

1	OBJECTIVE.....	4
2	PURPOSE .....	4
2.1	Functional Components.....	4
2.2	Umbilical Prototype.....	4
3	REFERENCES .....	5
4	TERMS AND DEFINITIONS .....	5
5	INDEPENDENT VERIFICATION AGENT .....	6
6	UMBILICAL QUALIFICATION PROGRAM .....	6
6.1	Test Procedures .....	6
6.2	Functional Components Qualification .....	6
6.2.1	Thermoplastic Hoses .....	6
6.2.2	Metallic Tubes .....	6
6.2.3	Signal Electrical Cables .....	6
6.2.4	Power Electrical Cables.....	6
6.2.5	Fiber Optical Cables .....	7
6.3	Umbilical Prototype Qualification .....	7
6.3.1	Prototype Qualification Plan.....	7
6.3.2	Prototype Qualification Tests .....	7
6.3.2.1	Ultimate Tensile Load Test.....	8
6.3.2.2	Torsion Balance & Tension Test.....	9
6.3.2.3	Axial Stiffness Test.....	11
6.3.2.4	Bending Stiffness Test .....	13
6.3.2.5	Weight Evaluation Test .....	15
6.3.2.6	Installation Cyclic Bending Test.....	16
6.3.2.7	Tension-to-tension Test.....	19
6.3.2.8	Operation Cyclic Bending Test .....	21
6.3.3	Guidelines for Samples Dissection .....	23
6.3.3.1	Prototype Sample Structure .....	23
6.3.3.2	Armor Pots .....	24
6.3.3.3	Bend Stiffener .....	24
6.3.4	Verification Tests on Functional Components .....	24
6.3.4.1	Thermoplastic Hoses.....	25
6.3.4.2	Metallic Tubes.....	26

	<b>TECHNICAL SPECIFICATION</b>	No. <b>I-ET-3000.00-1500-29B-PAZ-006</b>	REV. <b>B</b>
	<b>UMBILICAL SYSTEMS FOR SUBSEA APPLICATION</b>		SHEET <b>3</b> of <b>28</b>
	TITLE:	<b>QUALIFICATION FOR POWER, CONTROL AND INJECTION UMBILICALS</b>	<b>NP-1</b>
			<b>SUB/ES/DCT</b>

6.3.4.3	Signal Electrical Cables.....	26
6.3.4.4	Power Electrical Cables .....	26
6.3.4.5	Fiber Optical Cable.....	27
6.4	Tests Accomplishment.....	27
6.5	Qualification Reports .....	27
6.5.1	Functional Component Qualification Report.....	27
6.5.2	Prototype Qualification Report .....	28
6.6	Qualification Accomplishment.....	28

	TECHNICAL SPECIFICATION	No. I-ET-3000.00-1500-29B-PAZ-006	REV. B
	UMBILICAL SYSTEMS FOR SUBSEA APPLICATION		SHEET 4 of 28
	TITLE: QUALIFICATION FOR POWER, CONTROL AND INJECTION UMBILICALS		NP-1

## 1 OBJECTIVE

This specification defines the Umbilical Qualification Program (UQP) for power, control and injection subsea round umbilicals. It is applicable to umbilicals containing functional components either alone or in combination, either for static or dynamic service.

This specification does not apply to umbilicals for completion/workover riser systems, neither for ROV (remotely operated vehicle) operations.

## 2 PURPOSE

The UQP establishes general requirements for the qualification of functional components and the umbilical prototype.

The first purpose of the UQP is to guarantee that the proposed umbilical structure will be feasible to operate on a determined scenario. If qualification tests results are outside of the specified range for the acceptance criterion(a), MANUFACTURER shall demonstrate that the prototype is fit for purpose for the design scenario according to limit values of MANUFACTURER's actual design methodology, otherwise the MANUFACTURER shall redesign the umbilical structure and perform the prototype testing again. The qualification tests results shall not be understood as prototype's structural capacity.

The second purpose of the UQP is to verify the design methodology applied by MANUFACTURER to evaluate the structural capacity of the umbilical. Whenever the qualification test results are outside the tolerance allowed for the predicted values obtained by MANUFACTURER's design methodology, the MANUFACTURER shall submit to Petrobras a plan to adjust and validate the design methodology including new prototype tests in order to demonstrate that. In addition, this plan shall include all the corrective actions to address the observed issues, those from the manufacturing, materials or design.

If, for whatever reason, MANUFACTURER achieves only the first purpose, PETROBRAS understands that the umbilical prototype is qualified, nevertheless MANUFACTURER's design methodology is not. The ultimate goal of the second purpose is to reduce the qualification scope in future processes, through the validation of MANUFACTURER's design methodology.

### 2.1 Functional Components

Qualification requirements for umbilical functional components are defined on specific PETROBRAS documents, which are mentioned on section 6.2.

### 2.2 Umbilical Prototype

Qualification Tests shall subject prototype samples to predefined loadings in order to determine umbilical's mechanical properties or to simulate its installation, operation and recovery loadings.

The umbilical prototype samples shall be representative from the manufacturing processes of the product to be supplied.

All functional components are under evaluation during the course of the umbilical prototype qualification. It means that even if a functional component is already qualified as a single product (under requirements stated on section 6.2), it must keep its performance while operating within the umbilical structure, with acceptance criteria defined by PETROBRAS on section 6.3.4.

	TECHNICAL SPECIFICATION	No. I-ET-3000.00-1500-29B-PAZ-006	REV. B
	UMBILICAL SYSTEMS FOR SUBSEA APPLICATION		SHEET 5 of 28
	TITLE: QUALIFICATION FOR POWER, CONTROL AND INJECTION UMBILICALS		NP-1
			SUB/ES/DCT

### 3 REFERENCES

*NOTE:* Unless otherwise stated, the latest revision of the following documents shall be considered.

- [1] ISO 13628-5, *Petroleum and natural gas industries - Design and operation of subsea production systems - Part 5: Subsea umbilicals*
- [2] I-ET-3000.00-1500-29B-PAZ-001, *Technical Specification for Subsea Umbilicals*
- [3] I-ET-3000.00-1500-29B-PAZ-003, *3/8" and 1/2" ID Hydraulic Hoses*
- [4] I-ET-3000.00-1500-29B-PAZ-004, *1/2" ID Hoses for Chemical Injection*
- [5] I-ET-3000.00-1500-29B-PAZ-005, *Metallic Tubes for Subsea Umbilicals*
- [6] I-ET-3500.00-1500-721-PAZ-003, *Electrical Power Cable Element & Testing*
- [7] IEC 60793-1-46, *Optical Fibers - Measurement Methods and Test Procedures - Monitoring of Changes in Optical Transmittance*

### 4 TERMS AND DEFINITIONS

#### ***Aged***

Condition of a functional component after the start of a qualification test on an umbilical prototype sample

#### ***Design tensile load***

Maximum tensile load multiplied by the utilization factor associated to the failure mechanism that infringes the stress criterion or causes loss of performance considering the Normal Recurrent Operation load condition. Due to the different utilization factors, the maximum tensile load and the design tensile load may be defined by different components.

#### ***High collapse-resistant hose (or HCR hose)***

Thermoplastic hose with an interlocking carcass inside the liner to provide resistance to external hydrostatic pressure

#### ***Hydraulic control hose***

Thermoplastic hoses intended for control functions

#### ***Prototype failure***

It is the loss of performance of one or more umbilical component(s) - functional or not - and/or umbilical accessory(ies) due to the load(s) applied on a prototype qualification test

#### ***Test rig***

Apparatus specially designed to perform one or more qualification test(s)

#### ***Umbilical prototype (or simply prototype)***

Product which concept, constituting materials, design methodologies, manufacturing processes and/or prototype testing results have not been reviewed and accepted by an Independent Verification Agent and which performance has not been approved by PETROBRAS through results, submitted by the MANUFACTURER, of theoretical complementary analyses and of prototype qualification tests.

	TECHNICAL SPECIFICATION	No. I-ET-3000.00-1500-29B-PAZ-006	REV. B
	UMBILICAL SYSTEMS FOR SUBSEA APPLICATION		SHEET 6 of 28
	TITLE: QUALIFICATION FOR POWER, CONTROL AND INJECTION UMBILICALS		NP-1
			SUB/ES/DCT

### ***Unaged***

Condition of a functional component before a qualification test on an umbilical prototype sample

## **5 INDEPENDENT VERIFICATION AGENT**

The UQP shall be followed by PETROBRAS and an Independent Verification Agent (IVA). PETROBRAS may not witness one or more tests at its own discretion, regarding the fact that the IVA shall be present in all of them.

All documentation generated under the scope of the UQP shall be fully reviewed by the IVA. All comments issued by the IVA on these documents shall be submitted to PETROBRAS under the scope of the Qualification Report, as stated on section 6.5.

A final Independent Review Certificate (IRC) shall be issued by the IVA summarizing the results of the whole qualification process in a technical report demonstrating that the proposed product and ancillary equipment fulfill the requirements of this specification.

## **6 UMBILICAL QUALIFICATION PROGRAM**

### **6.1 Test Procedures**

MANUFACTURER shall present specific procedures for the qualification tests required hereafter (for functional components and umbilical prototype). Test Procedures must fulfill the test requirements described on sections 6.2 and 6.3, including dissection when applicable.

New Test Procedures and new revisions of already existing Test Procedures must have PETROBRAS approval prior to the start of the respective Qualification Tests. Approved Test Procedures are applicable to all UQPs.

### **6.2 Functional Components Qualification**

#### **6.2.1 Thermoplastic Hoses**

The qualification of a thermoplastic hose shall follow the requirements of [3] or [4].

#### **6.2.2 Metallic Tubes**

The qualification of metallic tubes shall follow the requirements of [5].

#### **6.2.3 Signal Electrical Cables**

MANUFACTURER shall refer to the specific Material Requisition to find the applicable Technical Specification where the qualification requirements are established.

#### **6.2.4 Power Electrical Cables**

The qualification of power electrical cables shall follow the requirements of [6].

	TECHNICAL SPECIFICATION	No. I-ET-3000.00-1500-29B-PAZ-006	REV. B
	UMBILICAL SYSTEMS FOR SUBSEA APPLICATION		SHEET 7 of 28
	TITLE: QUALIFICATION FOR POWER, CONTROL AND INJECTION UMBILICALS		NP-1
			SUB/ES/DCT

### 6.2.5 Fiber Optical Cables

MANUFACTURER shall refer to the specific Material Requisition to find the applicable Technical Specification where the qualification requirements are established.

## 6.3 Umbilical Prototype Qualification

### 6.3.1 Prototype Qualification Plan

Prior to prototype qualification testing, MANUFACTURER shall submit a Prototype Qualification Plan to PETROBRAS. This Prototype Qualification Plan shall inform, for each Prototype Qualification Test:

- Inspection and test qualification plan
- applicable MANUFACTURER's Test Procedure, including its revision;
- load(s) to be applied on umbilical prototype sample(s);
- expected results (when applicable). MANUFACTURER shall clearly demonstrate its methodology to estimate the expected results informing, for example, adopted theory, software tools, technical references, etc. These theoretical values shall be compared with the experimental results;
- verification tests to be performed on functional components, with associated parameters and, when applicable, acceptance criteria.

The prototype qualification tests shall be carried out only after PETROBRAS approval on the Prototype Qualification Plan.

### 6.3.2 Prototype Qualification Tests

Prototype Qualification Tests are divided in static and dynamic tests, as listed below:

#### Static Tests

6.3.2.1 Ultimate Tensile Load Test

6.3.2.2 Torsion Balance & Tension Test

6.3.2.3 Axial Stiffness Test

6.3.2.4 Bending Stiffness Test

6.3.2.5 Weight Evaluation Test

#### Dynamic Tests

6.3.2.6 Installation Cyclic Bending Test

6.3.2.7 Tension-to-tension Test

6.3.2.8 Operation Cyclic Bending Test

	TECHNICAL SPECIFICATION	No. I-ET-3000.00-1500-29B-PAZ-006	REV. B
	UMBILICAL SYSTEMS FOR SUBSEA APPLICATION		SHEET 8 of 28
	TITLE: QUALIFICATION FOR POWER, CONTROL AND INJECTION UMBILICALS		NP-1
			SUB/ES/DCT

### 6.3.2.1 Ultimate Tensile Load Test

#### Objective

Verify MANUFACTURER's methodology to determine the ultimate tensile load.

#### Procedure

The prototype sample shall be assembled on a tension test rig with one end fixed and the other free to rotate. The tensile load shall be increased at a rate not exceeding 300 kN/min up to prototype failure.

MANUFACTURER shall provide mechanism(s) to detect prototype failure. At MANUFACTURER's decision the test will be ended, and the sample shall be disassembled and dissected following guidelines on section 6.3.3 to confirm prototype failure.

#### Minimum Sample Length

6 (six) pitch lengths of the outer armor wire, measured between the external faces of the armor pots. If unarmored, the minimum sample length shall be, at least, 8 m.

#### Hoses/Tubes Pressure Level

Maximum working pressure

#### Hoses/Tubes Pressure Monitoring

Yes

#### Continuity Monitoring (signal electrical, power electrical and fiber optical cables)

Yes (regarding fiber optical cables continuity monitoring, please refer to section 6.3.4)

#### Load(s)

Increasing tensile load at a rate not exceeding 300 kN/min up to prototype failure.

#### Data to be recorded throughout the test

- Tensile load

#### Verification Tests on Functional Components

No

#### Test Acceptance Criteria

- Tension at which the prototype failure occurs shall be within -5 / +15% of the theoretical value.
- Electrical/Optical continuity shall be maintained until prototype failure

#### Special Note(s)

- At least 3% of the armor wires shall be welded according to MANUFACTURER's procedure in the prototype sample. These armor wire welds shall be equally distributed among the armoring layers.
- MANUFACTURER shall propose a direct way of measuring the applied tension.



	TECHNICAL SPECIFICATION	No. I-ET-3000.00-1500-29B-PAZ-006	REV. B
	UMBILICAL SYSTEMS FOR SUBSEA APPLICATION		SHEET 9 of 28
	TITLE: QUALIFICATION FOR POWER, CONTROL AND INJECTION UMBILICALS		NP-1
			SUB/ES/DCT

## Report

An Ultimate Tensile Load Test Report shall be submitted to PETROBRAS including at least the following:

- Sample actual pitch and total lengths
- Graphs showing the tensile load variation, pressure on hoses/tubes and electrical/optical continuity throughout the test
- Comparison between the theoretical value presented on the Prototype Qualification Plan and the experimental result obtained in the test
- Dissection appraisal
- Calibration certificates of all measuring devices used in the test

### **6.3.2.2 Torsion Balance & Tension Test**

#### Objective

Measure the residual twist of the sample and evaluate the performance of the umbilical system under pure tension when loaded up to the design tensile load.

#### Procedure

The prototype sample shall be assembled on a test rig with one end fixed and the other free to rotate. Before the test start, the tensile load shall be slowly applied until the sample reaches a straight position. The preload tension shall be the minimum necessary to keep the sample on this straight position. This preload tension shall be recorded and informed on the test report. The sample shall be kept under this tensile load for a minimum of 15 (fifteen) minutes. After that time, the rotation measurement system shall be reset.

*Note:* Rotation shall be measured by means of two points over the umbilical most external structural layer, using devices that do not induce compression over the prototype structure.

After preloading the prototype sample and resetting the rotation measurement system, the tensile load shall be increased from the preload tension up to the theoretical design tensile load. The ramp-up shall be divided in a minimum of 5 (five) blocks, with approximately equal load increments. Within each load block, the tensile load shall be increased at a rate sufficiently low in order to not introduce shock loads, and the hold duration at block's maximum tensile load must be at least 15 (fifteen) minutes, except for the last block – where the theoretical design tensile load is reached. Hold duration for the last block must be at least 60 (sixty) minutes.

MANUFACTURER shall propose the number of load blocks and their load increments based on the above.

After 60 (sixty) minutes under the theoretical design tensile load, the prototype sample shall be unloaded down to the preload tension. The ramp-down shall adopt the same load blocks adopted for loading the sample, including the hold duration time of 15 (fifteen) minutes at each load step. Within each load block, the tensile load shall be decreased at a rate sufficiently low in order to not introduce

	TECHNICAL SPECIFICATION	No. I-ET-3000.00-1500-29B-PAZ-006	REV. B
	UMBILICAL SYSTEMS FOR SUBSEA APPLICATION		SHEET 10 of 28
	TITLE: QUALIFICATION FOR POWER, CONTROL AND INJECTION UMBILICALS		NP-1
			SUB/ES/DCT

shock loads. When the preload tension is reached, the sample shall be kept under this tensile load for a minimum of 15 (fifteen) minutes.

At MANUFACTURER's decision, the prototype sample may undergo loading and unloading cycles following the defined load blocks (including hold duration times) to achieve stable rotation readings.

On all load blocks, after the hold duration time, the rotation shall be measured and informed on the test report. These values are for information only, except for the readings made under the preload tension and the design tensile load. For these, the acceptance criteria stated on Table I apply.

Lastly the sample shall be disassembled and dissected following guidelines on section 6.3.3. Functional components shall be tested following requirements stated on section 6.3.4..

Minimum Sample Length

6 (six) pitch lengths of the outer armor wire, measured between the external faces of the armor pots. If unarmored, the minimum sample length shall be, at least, 8 m.

Hoses/Tubes Pressure Level

3,000 psi

Hoses/Tubes Pressure Monitoring

Yes

Continuity Monitoring (signal electrical, power electrical and fiber optical cables)

Yes (regarding fiber optical cables continuity monitoring, please refer to section 6.3.4)

Load(s)

Five equal tensile load increments from 100 kN up to the design tensile load -0 / +2 %

Data to be recorded throughout the test

- Tensile load
- Hoses pressure
- Electrical/Optical continuity

Verification Tests on Functional Components

Yes (refer to section 6.3.4)

Test Acceptance Criteria

- Sample rotation as per Table I:

**Table I - Acceptance criteria for sample rotation**

LOADED	UNLOADED (RESIDUAL)
± 0.4°/m	± 0.2°/m

	TECHNICAL SPECIFICATION	No. I-ET-3000.00-1500-29B-PAZ-006	REV. B
	UMBILICAL SYSTEMS FOR SUBSEA APPLICATION		SHEET 11 of 28
	TITLE: QUALIFICATION FOR POWER, CONTROL AND INJECTION UMBILICALS		NP-1
			SUB/ES/DCT

- No prototype failure at any step of the test
- Hoses/Tubes pressure shall be maintained throughout the test with maximum variation of  $\pm 10\%$
- Electrical/Optical continuity shall be maintained throughout the test
- No visible prototype failure during dissection
- Verification tests on functional components must successfully accomplish their respective acceptance criteria (when applicable)

#### Special Note(s)

- MANUFACTURER shall propose a direct way of measuring the applied tension
- The rotation measurement system shall have a minimum resolution of  $0.01^\circ$
- The rotation measurement devices shall be at a distance of 1 (one) pitch length of each armor pot external face, i.e. the distance between the devices will be at least 4 (four) pitch lengths

#### Report

A Torsion Balance & Tension Test Report shall be submitted to PETROBRAS including at least the following:

- Sample actual pitch and total lengths
- Graphs showing the tensile load variation, pressure on hoses/tubes and electrical/optical continuity throughout the test
- Sample rotation results
- Dissection appraisal
- Verification tests results
- Calibration certificates of all measuring devices used in the test

#### **6.3.2.3 Axial Stiffness Test**

##### Objective

Verify MANUFACTURER's methodology to determine umbilical's axial stiffness up to the design tensile load.

##### Procedure

The prototype sample shall be assembled on a tension test rig with one end fixed and the other free to rotate. It shall be loaded up to the design tensile load. During loading, elongation of the sample shall be continuously recorded. Elongation shall be measured by means of two points over the external armor

	TECHNICAL SPECIFICATION	No. I-ET-3000.00-1500-29B-PAZ-006	REV. B
	UMBILICAL SYSTEMS FOR SUBSEA APPLICATION		SHEET 12 of 28
	TITLE: QUALIFICATION FOR POWER, CONTROL AND INJECTION UMBILICALS		NP-1

layer using devices that do not induce compression over the prototype structure. If unarmored, elongation shall be measured over the most external layer.

MANUFACTURER shall propose a load-up method (number of load increments, tension at each increment, hold duration, etc.) and how many load-ups the same sample shall undergo so as to reach a reliable value. Additionally it shall inform at which tension range the tension-displacement relationship is deemed to be valid (notably at lower tensions the axial stiffness behavior is erratic). As stated on sections 6.1 and 6.3.1, the procedure and the Prototype Qualification Plan must have PETROBRAS approval prior to test execution.

Both the theoretical and the experimental axial stiffness shall be presented in a graphical form (Tension x Displacement).

The test shall be performed on 3 (three) different samples. Each experimental graph (instead of an average) shall be compared to the theoretical one.

#### Minimum Sample Length

6 (six) pitch lengths of the outer armor wire, measured between the external faces of the armor pots. If unarmored, the minimum sample length shall be, at least, 8 m.

#### Hoses/Tubes Pressure Level

Not Applicable

#### Hoses/Tubes Pressure Monitoring

Not Applicable

#### Continuity Monitoring (signal electrical, power electrical and fiber optical cables)

No

#### Load(s)

Tensile load to be applied up to the design tensile load, according to approved MANUFACTURER's procedure.

#### Data to be recorded throughout the test

- Tensile load
- Sample Elongation
- Ambient Temperature

#### Verification Tests on Functional Components

No

	TECHNICAL SPECIFICATION	No. I-ET-3000.00-1500-29B-PAZ-006	REV. B
	UMBILICAL SYSTEMS FOR SUBSEA APPLICATION		SHEET 13 of 28
	TITLE: QUALIFICATION FOR POWER, CONTROL AND INJECTION UMBILICALS		NP-1
			SUB/ES/DCT

### Test Acceptance Criteria

- Experimental values shall be within  $\pm 15\%$  of the theoretical ones for every point on the graphs

### Special Note(s)

- MANUFACTURER shall propose a direct way of measuring the applied tension
- The displacement measurement system shall have a minimum resolution of 0.01 m
- The displacement measurement devices shall be at a distance of 1 (one) pitch length of each armor pot external face, i.e. the distance between the devices will be at least 4 (four) pitch lengths

### Report

An Axial Stiffness Test Report shall be submitted to PETROBRAS including at least the following:

- Sample actual pitch and total lengths
- Graphs showing the tensile load variation throughout the test
- Comparison between the theoretical graph presented on the Prototype Qualification Plan and the experimental result obtained in the test
- Ambient temperature at which the stiffness values were raised
- Calibration certificates of all measuring devices used in the test

#### **6.3.2.4 Bending Stiffness Test**

##### Objective

Verify MANUFACTURER's methodology to determine umbilical's bending stiffness down to the minimum bending radius.

##### Procedure

The prototype sample shall be flexed down to the predicted minimum bending radius. During loading, sample's radius of curvature shall be continuously recorded.

MANUFACTURER shall propose a load-up method (number of load increments, tension at each increment, hold duration, etc.), how many load-ups the same sample shall undergo to reach a reliable value and how the radius of curvature will be measured throughout the test. Additionally it shall inform at which moment range the moment-curvature relationship is deemed to be valid. As stated on sections 6.1 and 6.3.1, the procedure and the Prototype Qualification Plan must have PETROBRAS approval prior to test execution.

Both the theoretical and the experimental bending stiffness shall be presented in a graphical form (Moment x Curvature).

The test shall be performed on 3 (three) different samples. Each experimental graph (instead of an average) shall be compared to the theoretical one.

	TECHNICAL SPECIFICATION	No. I-ET-3000.00-1500-29B-PAZ-006	REV. B
	UMBILICAL SYSTEMS FOR SUBSEA APPLICATION		SHEET 14 of 28
	TITLE: QUALIFICATION FOR POWER, CONTROL AND INJECTION UMBILICALS		NP-1
			SUB/ES/DCT

Minimum Sample Length

6 (six) pitch lengths of the outer armor wire, measured between the fixed end and the point of load application. If unarmored, the minimum sample length shall be, at least, 10 m between the armour pots (face to face)

Hoses/Tubes Pressure Level

Not Applicable

Hoses/Tubes Pressure Monitoring

Not Applicable

Continuity Monitoring (signal electrical, power electrical and fiber optical cables)

No

Load(s)

Moment to be applied down to the minimum bending radius, according to approved MANUFACTURER's procedure.

Data to be recorded throughout the test

- Tensile load
- Sample radius of curvature
- Ambient Temperature

Verification Tests on Functional Components

No

Test Acceptance Criteria

- Experimental values shall be within  $\pm 20\%$  of the theoretical ones for every point on the graphs

Special Note(s)

- The radius of curvature measurement system shall have a minimum resolution of 0.01 m

Report

A Bending Stiffness Test Report shall be submitted to PETROBRAS including at least the following:

- Sample actual pitch and total lengths
- Graphs showing the bending radius variation throughout the test
- Comparison between the theoretical graph presented on the Prototype Qualification Plan and the experimental result obtained in the test
- Ambient temperature at which the stiffness values were raised

	TECHNICAL SPECIFICATION	No. I-ET-3000.00-1500-29B-PAZ-006	REV. B
	UMBILICAL SYSTEMS FOR SUBSEA APPLICATION		SHEET 15 of 28
	TITLE: QUALIFICATION FOR POWER, CONTROL AND INJECTION UMBILICALS		NP-1
			SUB/ES/DCT

- Calibration certificates of all measuring devices used in the test

### 6.3.2.5 Weight Evaluation Test

#### Objective

Verify MANUFACTURER's methodology to determine umbilical's weight per meter.

#### Procedure

Both ends of the sample shall be carefully cut in a transverse way relative to its longitudinal axis. Firstly, the sample shall be weighted in air.

For weight measurement under water, the sample shall be vertically positioned in a tank filled with water in order to allow the purge of any air inside the structure. At least 6 (six) hours shall elapse between the immersion of the sample and the weight verification, provided no air bubbles are detected when moving the immersed sample.

#### Minimum Sample Length

1 m  $\pm$  1%

#### Hoses/Tubes Pressure Level

Not Applicable

#### Hoses/Tubes Pressure Monitoring

No

#### Continuity Monitoring (signal electrical, power electrical and fiber optical cables)

No

#### Load(s)

None

#### Data to be recorded throughout the test

None

#### Verification Tests on Functional Components

No

#### Test Acceptance Criterion

- Experimental values shall be within  $\pm$  5% of the theoretical ones

#### Special Note(s)

- To calculate the weight per meter it must be considered the actual length of the sample
- The weight measurement system shall have a minimum resolution of 0.01 kg

	TECHNICAL SPECIFICATION	No. I-ET-3000.00-1500-29B-PAZ-006	REV. B
	UMBILICAL SYSTEMS FOR SUBSEA APPLICATION		SHEET 16 of 28
	TITLE: QUALIFICATION FOR POWER, CONTROL AND INJECTION UMBILICALS		NP-1

- Correction shall be made on the measured submerged weight in case of different water densities. Typically the calculated weight considers 1025 kg/m<sup>3</sup> (seawater density) and the test considers 1000 kg/m<sup>3</sup> (potable water density).

### Report

A Weight Evaluation Test Report shall be submitted to PETROBRAS including at least the following:

- Sample actual length
- The measured weights and the calculated weights per meter in air and in water. The last one shall be corrected, if applicable.
- Comparison between the theoretical values presented on the Prototype Qualification Plan and the experimental results obtained in the test
- The experimental P/d ratio
- Calibration certificates of all measuring devices used in the test

### 6.3.2.6 Installation Cyclic Bending Test

#### Objective

Evaluate the behavior of the completed umbilical due to the laying vessel motion during installation.

This test shall be executed only for structures up to 2,000m water depth scenarios.

#### Procedure

The prototype sample shall be assembled on a test rig according to Figure 1:

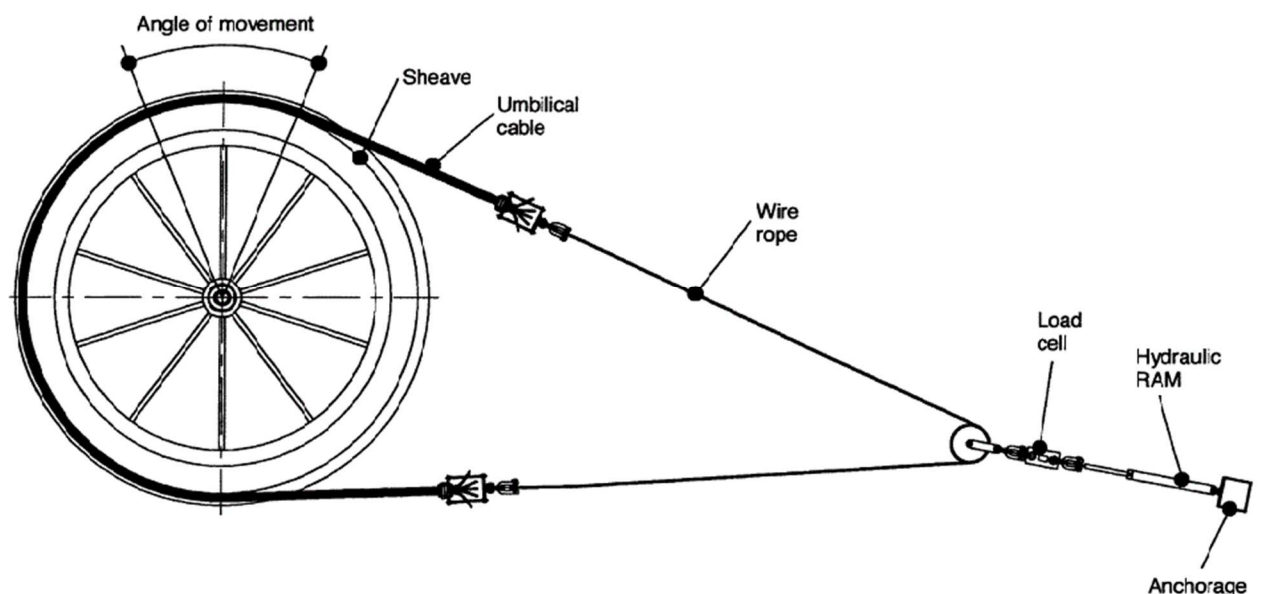



Figure 1 – Installation Cyclic Bending Test Jig



	TECHNICAL SPECIFICATION	No. I-ET-3000.00-1500-29B-PAZ-006	REV. B
	UMBILICAL SYSTEMS FOR SUBSEA APPLICATION		SHEET 17 of 28
	TITLE: QUALIFICATION FOR POWER, CONTROL AND INJECTION UMBILICALS		NP-1

The test rig must simulate a 3 (three) meter radius wheel of a laying vessel. The prototype sample shall be subjected to 5,400 cycles of non-reverse bending under tension, in order to simulate typical installation conditions at vessel exit region. Minimum length to be flexed and straightened is 400 mm.

At 1,800 cycles, and 3,600 cycles the prototype qualification test shall be stopped to perform verification tests on the signal and power electrical cables whenever they exist within the prototype sample. The verification tests to be performed are described on section 6.3.4, items 6.3.4.3 and 6.3.4.4. These verification tests results must be recorded.

After 5,400 cycles the sample shall be disassembled and dissected following guidelines on section 6.3.3. Functional components shall be tested following requirements stated on section 6.3.4.

#### Minimum Sample Length

Enough to assemble the prototype sample on the test rig

#### Hoses/Tubes Pressure Level

1,000 psi

#### Hoses/Tubes Pressure Monitoring

Yes

#### Continuity Monitoring (signal electrical, power electrical and fiber optical cables)

Yes (regarding fiber optical cables continuity monitoring, please refer to section 6.3.4)

#### Load(s)

The tension and the minimum angular velocity to be applied in the test shall be obtained in a dynamic analysis load case, considering the following:

- PLSV Sunrise 2000 at light draft
- Umbilical System under qualification
- 2,000 m Water Depth
- 1° departure angle in neutral position (no waves and no current)
- Regular head sea wave with 2.0 m height and 8.0 s period
- No current

The mean tension obtained in dynamic analysis shall be constantly applied during the test. Mean Tension is equal to (Maximum Tension + Minimum Tension) / 2.

The angle variation on the top connection of the analysis model ( $\Delta\alpha$ ) shall be obtained from the simulation. The angular velocity ( $\omega$ ) calculated from the simulation is as follows:

	TECHNICAL SPECIFICATION	No. I-ET-3000.00-1500-29B-PAZ-006	REV. B
	UMBILICAL SYSTEMS FOR SUBSEA APPLICATION		SHEET 18 of 28
	TITLE: QUALIFICATION FOR POWER, CONTROL AND INJECTION UMBILICALS		NP-1
			SUB/ES/DCT

$$\omega = \frac{2 \cdot \Delta\alpha}{T} \quad (1)$$

where  $T$  is the wave period (8.0 s). This is the minimum angular velocity to be applied during the test. The length to be flexed and straightened ( $\Delta L$ ) according to the simulation is calculated as follows:

$$\Delta L = \Delta\alpha \cdot R \quad (2)$$

where  $R$  is the wheel radius (3.0 m).

At MANUFACTURER's decision, if  $\Delta L$  is less than the minimum specified length to be flexed and straightened (400 mm), the test period may be increased to maintain the minimum angular velocity or a higher angular velocity can be proposed to speed up test execution.

The output data from dynamic analysis and MANUFACTURER's considerations on the test parameters must be on the Prototype Qualification Plan.

#### Data to be recorded throughout the test

- Tensile load
- Prototype displacement (flexed and straightened length)
- Number of cycles
- Hoses/Tubes Pressure
- Electrical/Optical continuity

#### Verification Tests on Functional Components

Yes (refer to section 6.3.4)

#### Test Acceptance Criteria

- Tension shall be maintained within  $\pm 5\%$  of the calculated mean tension
- No prototype failure at any step of the test
- Hoses/Tubes pressure shall be maintained throughout the test with maximum variation of  $\pm 10\%$
- Electrical/Optical continuity shall be maintained throughout the test
- No visible prototype failure during dissection
- Verification tests on functional components must successfully accomplish their respective acceptance criteria (when applicable)

	TECHNICAL SPECIFICATION	No. I-ET-3000.00-1500-29B-PAZ-006	REV. B
	UMBILICAL SYSTEMS FOR SUBSEA APPLICATION		SHEET 19 of 28
	TITLE: QUALIFICATION FOR POWER, CONTROL AND INJECTION UMBILICALS		NP-1
			SUB/ES/DCT

### Special Note(s)

MANUFACTURER shall propose a direct way of measuring the applied tension

### Report

An Installation Cyclic Bending Test Report shall be submitted to PETROBRAS including at least the following:

- Sample actual pitch and total lengths
- Graphs showing the tensile load variation, prototype displacement, pressure on hoses/tubes and electrical/optical continuity throughout the test
- Dissection appraisal
- Verification tests results
- Calibration certificates of all measuring devices used in the test

### **6.3.2.7 Tension-to-tension Test**

#### Objective

Verify MANUFACTURER's methodology to calculate fatigue life of an umbilical system under pure tension loads.

#### Procedure

The prototype sample shall be assembled on a tension test rig with one end fixed and the other free to rotate. It shall be subjected to cyclic tensile loads below the design tensile load in a predefined number of cycles to achieve prototype failure due to fatigue (fatigue damage = 1.0).

MANUFACTURER shall propose the number of cyclic load blocks (minimum of four), the tensile loads values and the number of cycles within each load block. Predicted total number of cycles until prototype failure must be at least 1,000,000 and at the most 2,000,000. As stated on sections 6.1 and 6.3.1, the procedure and the Prototype Qualification Plan must have PETROBRAS approval prior to test execution.

MANUFACTURER shall provide mechanism(s) to detect prototype failure. At MANUFACTURER's decision the test will be ended, and the sample shall be disassembled and dissected following guidelines on section 6.3.3 to confirm prototype failure.

#### Minimum Sample Length

6 (six) pitch lengths of the outer armor wire, measured between the external faces of the armor pots. If unarmored, the minimum sample length shall be, at least, 10 m between armour pots (face to face)

#### Hoses/Tubes Pressure Level

Maximum Working Pressure

	TECHNICAL SPECIFICATION	No. I-ET-3000.00-1500-29B-PAZ-006	REV. B
	UMBILICAL SYSTEMS FOR SUBSEA APPLICATION		SHEET 20 of 28
	TITLE: QUALIFICATION FOR POWER, CONTROL AND INJECTION UMBILICALS		NP-1
			SUB/ES/DCT

Hoses/Tubes Pressure Monitoring

Yes

Continuity Monitoring (signal electrical, power electrical and fiber optical cables)

Yes (regarding fiber optical cables continuity monitoring, please refer to section 6.3.4)

Load(s)

Tensile load blocks according to approved MANUFACTURER's procedure.

Data to be recorded throughout the test

- Tensile load
- Number of cycles
- Hoses/Tubes pressure
- Electrical/Optical continuity

Verification Tests on Functional Components

No

Test Acceptance Criteria

- Number of test cycles until prototype failure shall be within  $\pm 100,000$  cycles of the predicted total number of cycles to failure on the Prototype Qualification Plan
- Hoses/Tubes pressure shall be maintained with maximum variation of  $\pm 10\%$  until prototype failure
- Electrical/Optical continuity shall be maintained until prototype failure

Special Note(s)

- At least 3% of the armor wires shall be welded according to MANUFACTURER's procedure in the prototype sample. These armor wire welds shall be equally distributed among the armoring layers.
- MANUFACTURER shall propose a direct way of measuring the applied tension

Report

A Tension-to-Tension Test Report shall be submitted to PETROBRAS including at least the following:

- Sample actual pitch and total lengths
- Graphs showing the tensile load variation, pressure on hoses/tubes and electrical/optical continuity throughout the test

	TECHNICAL SPECIFICATION	No. I-ET-3000.00-1500-29B-PAZ-006	REV. B
	UMBILICAL SYSTEMS FOR SUBSEA APPLICATION		SHEET 21 of 28
	TITLE: QUALIFICATION FOR POWER, CONTROL AND INJECTION UMBILICALS		NP-1
			SUB/ES/DCT

- Comparison between the theoretical value presented on the Prototype Qualification Plan and the experimental result obtained in the test relative to the number of cycles to prototype failure
- Dissection appraisal
- Calibration certificates of all measuring devices used in the test

### 6.3.2.8 Operation Cyclic Bending Test

#### Objective

Evaluate the behavior of the completed umbilical when subjected to cyclic combined tension and bending loads until the maximum allowable fatigue damage is reached.

#### Procedure

The prototype sample shall be assembled on a fatigue test rig with one end fixed and the other free to rotate. It shall be subjected to cyclic combined tension and bending loads in a predefined number of cycles to achieve the maximum allowable fatigue damage. The maximum allowable fatigue damage is equal to 1.0 divided by the design fatigue factor (see [2]).

MANUFACTURER shall at its own discretion propose the number of cyclic load blocks (minimum of six), the tension-angle pairs and the number of cycles within each load block. Predicted total number of cycles until maximum allowable fatigue damage must be at least 1,900,000 and at the most 2,100,000. As stated on sections 6.1 and 6.3.1, the procedure and the Prototype Qualification Plan must have PETROBRAS approval prior to test execution.

At 400,000 cycles, 800,000 cycles, 1,200,000 cycles and 1,600,000 cycles, the prototype qualification test shall be stopped to perform verification tests on the signal and power electrical cables whenever they exist within the prototype sample. The verification tests to be performed are described on section 6.3.4, items 6.3.4.3 and 6.3.4.4. These verification tests results must be recorded.

When the proposed number of cycles is reached, the sample shall be disassembled and dissected following guidelines on section 6.3.3. Functional components shall be tested following requirements stated on section 6.3.4.

#### Minimum Sample Length

3 (three) pitch lengths of the outer armor wire, measured between the tip end of the bend stiffener and the external face of the armor pot. If unarmored, the minimum sample length is 10 m.

#### Hoses/Tubes Pressure Level

Maximum Working Pressure

#### Hoses/Tubes Pressure Monitoring

Yes

#### Continuity Monitoring (signal electrical, power electrical and fiber optical cables)

Yes (regarding fiber optical cables continuity monitoring, please refer to section 6.3.4)

	TECHNICAL SPECIFICATION	No. I-ET-3000.00-1500-29B-PAZ-006	REV. B
	UMBILICAL SYSTEMS FOR SUBSEA APPLICATION		SHEET 22 of 28
	TITLE: QUALIFICATION FOR POWER, CONTROL AND INJECTION UMBILICALS		NP-1
			SUB/ES/DCT

### Load(s)

Tension-angle pairs according to approved MANUFACTURER's procedure.

### Data to be recorded throughout the test

- Tensile load
- Angular variation
- Number of cycles
- Hoses/Tubes pressure
- Electrical/Optical continuity

### Verification Tests on Functional Components

Yes (refer to section 6.3.4)

### Test Acceptance Criteria

- No prototype failure at any step of the test
- Hoses/Tubes pressure shall be maintained throughout the test with maximum variation of  $\pm 10\%$
- Electrical/Optical continuity shall be maintained throughout the test
- No visible prototype failure during dissection
- Verification tests on functional components must successfully accomplish their respective acceptance criteria (when applicable)

### Special Note(s)

- MANUFACTURER shall propose a direct way of measuring the applied tension
- The angular variation measurement system shall have a minimum resolution of  $0.1^\circ$

### Report

An Operation Cyclic Bending Test Report shall be submitted to PETROBRAS including at least the following:

- Sample actual pitch and total lengths
- Graphs showing the tensile load variation, angle variation, pressure on hoses/tubes and electrical/optical continuity throughout the test
- Dissection appraisal
- Verification tests results

	TECHNICAL SPECIFICATION	No. I-ET-3000.00-1500-29B-PAZ-006	REV. B
	UMBILICAL SYSTEMS FOR SUBSEA APPLICATION		SHEET 23 of 28
	TITLE: QUALIFICATION FOR POWER, CONTROL AND INJECTION UMBILICALS		NP-1
			SUB/ES/DCT

- Calibration certificates of all measuring devices used in the test

### 6.3.3 Guidelines for Samples Dissection

As stated on section 6.3.2, after the Torsion Balance & Tension, Installation Cyclic Bending and Operation Cyclic Bending tests, the prototype samples shall be dissected to look for minor failures and to perform verification tests on aged functional components. As also stated on section 6.3.2, after the Ultimate Tensile Load and Tension-to-Tension tests the samples shall be dissected to confirm prototype failure.

The whole prototype sample shall be inspected, i.e. the prototype structure (including the sections inside the armor pots), armor pots and the bend stiffener used on the Operation Cyclic Bending Test.

The following actions are considered as a minimum by PETROBRAS and must be in MANUFACTURER's Test Procedures. As stated on section 6.3.2, additional actions may be proposed by the MANUFACTURER. In case of prototype failure during test execution, PETROBRAS and MANUFACTURER may agree further actions than those on the Test Procedure to better investigate the event.

#### 6.3.3.1 Prototype Sample Structure

All possible precaution shall be taken to ensure that the armor wires will not be damaged by the equipments used to remove the outer sheath and the armor pots. These removal procedures shall be defined by the MANUFACTURER.

Relevant observations such as broken wires, bird cages, excessive wear, etc., shall be recorded and informed to PETROBRAS. In case of broken wires, special care shall be taken to keep them intact and preserved for further analyses, if necessary.

The resin inside the armor pots shall be free of cracks (unless this is the prototype failure mechanism predicted by the MANUFACTURER for the Ultimate Tensile Load and Tension-to-Tension tests). Possible sliding from the armor pot body must be checked.

When the prototype structure presents signal and/or power electrical cables, their conductors shall be stripped to look for failures on the copper core strands.

#### Torsion Balance & Tension, Ultimate Tensile Load and Tension-to-Tension Tests

Equally spaced marks (maximum distance of 0.5 m) shall be made on prototype outer sheath to make easier to locate a possible failure. These marks shall be transferred to the armor layers during dissection.

For the Torsion Balance & Tension Test, the samples of aged hoses and/or tubes for the verification tests shall be taken from the middle section of the prototype sample.

#### Installation Cyclic Bending Test

Before removing the sample from the test rig, the neutral and bending planes shall be identified on the prototype outer sheath. These marks shall be transferred to the armor layers during dissection. They shall be extended to the wires inside the armor pot after its removal.

The flexed and straightened length shall be clearly identified. Equally spaced marks (maximum distance of 0.5 m) shall be made on the outer sheath of the remaining prototype length. These marks shall be

	TECHNICAL SPECIFICATION	No. I-ET-3000.00-1500-29B-PAZ-006	REV. B
	UMBILICAL SYSTEMS FOR SUBSEA APPLICATION		SHEET 24 of 28
	TITLE:	QUALIFICATION FOR POWER, CONTROL AND INJECTION UMBILICALS	NP-1
			SUB/ES/DCT

transferred to the armor layers during dissection (including those from the flexed and straightened length).

The samples of aged hoses and/or tubes for the verification tests shall be taken from the flexed and straightened length of the prototype sample.

#### Operation Cyclic Bending Test

Before removing the sample from the test rig, the neutral and bending planes shall be identified on the prototype outer sheath. These marks shall be transferred to the armor layers during dissection. They shall be extended to the wires inside the armor pot after its removal.

Some distinguished sections of the bend stiffener shall be marked on prototype outer sheath after stiffener removal. These sections are:

- End of the metallic insert inside the stiffener
- Beginning of the tapered section
- End of the tapered section
- End of the stiffener

In some cases, the end of the metallic insert is coincident with the beginning of the tapered section and/or the end of the tapered section is coincident with the end of the bend stiffener.

Equally spaced marks (maximum distance of 0.5 m) shall be made on the outer sheath of the remaining prototype length. These marks shall be transferred to the armor layers during dissection (including those from the bend stiffener).

The samples of aged hoses and/or tubes for the verification tests shall be taken from the part of the prototype sample inside the tapered section of the bend stiffener.

#### **6.3.3.2 Armor Pots**

The armor pots shall be disassembled from the prototype sample after the qualification test execution. As stated on item I of this section, the disassembling must be according to MANUFACTURER's procedure and shall keep the anchorage region (armor wires and resin) integrity.

The armor pots shall be visually inspected to search for failures. Any relevant observation shall be recorded and informed to PETROBRAS.

#### **6.3.3.3 Bend Stiffener**

The outer surface of the bend stiffener shall be visually inspected for damage, cracks or any other flaws. Any relevant observation shall be recorded and informed to PETROBRAS.

#### **6.3.4 Verification Tests on Functional Components**

As stated on section 6.3.2, for the Torsion Balance & Tension, Installation Cyclic Bending and Operation Cyclic Bending Tests, the functional components shall be subjected to verification tests (some with defined acceptance criteria) as part of the UQP. These tests are described on the following sections.



	TECHNICAL SPECIFICATION	No. I-ET-3000.00-1500-29B-PAZ-006	REV. B
	UMBILICAL SYSTEMS FOR SUBSEA APPLICATION		SHEET 25 of 28
	TITLE: QUALIFICATION FOR POWER, CONTROL AND INJECTION UMBILICALS		NP-1
			SUB/ES/DCT

#### 6.3.4.1 Thermoplastic Hoses

The following tests shall be performed after the Prototype Qualification Test for the hoses of the dissected umbilical prototype, with the same procedures and acceptance criteria adopted for unaged hoses (refer to [1], [3] and [4]):

- Visual and Dimensional Check
- Leakage Test
- Burst Test
- Collapse Test (only for HCR hoses) and
- Volumetric Expansion Test (only for hydraulic control hoses)

All hoses must be subjected to Visual and Dimensional Check. For the other tests, the number of hoses is defined as follows:

**Table II - Number of HCR hoses for verification tests**

Total Number of HCR Hoses within the Prototype	Number of HCR hoses to be tested		
	Leakage Test	Collapse Test	Burst Test
<b>Less than 3</b>	PETROBRAS shall be consulted		
<b>3 or 4</b>	1	1	Remaining sample(s)
<b>More Than 4</b>	1	2	Remaining samples

**Table III - Number of hydraulic control hoses for verification tests**

Total Number of Hydraulic Control Hoses within the Prototype	Number of hydraulic control hoses to be tested		
	Leakage Test	Volumetric Expansion Test	Burst Test
<b>Less than 3</b>	PETROBRAS shall be consulted		
<b>3 or 4</b>	1	1	Remaining sample(s)
<b>More Than 4</b>	2	1	Remaining samples

	TECHNICAL SPECIFICATION	No. I-ET-3000.00-1500-29B-PAZ-006	REV. B
	UMBILICAL SYSTEMS FOR SUBSEA APPLICATION		SHEET 26 of 28
	TITLE: QUALIFICATION FOR POWER, CONTROL AND INJECTION UMBILICALS		NP-1
			SUB/ES/DCT

#### 6.3.4.2 Metallic Tubes

The following tests shall be performed after the Prototype Qualification Test for the metallic tubes of the dissected umbilical prototype, with the same procedures and acceptance criteria adopted for unaged tubes (refer to [1] and [5]):

- Visual and Dimensional Check, with an acceptance criteria of 5 % for ovality
- Pressure Test
- Burst Test and
- Non Destructive Examination (NDE) of welds

All tubes must be subjected to Visual and Dimensional Check. All welds must be subjected to NDE. Two samples shall be subjected to Pressure Test and the remaining samples shall be subjected to Burst Test.

#### 6.3.4.3 Signal Electrical Cables

The following tests shall be performed before, during (at number of cycles stated on items 6.3.2.6 and 6.3.2.8 of section 6.3.2) and after the Prototype Qualification Test, for every signal electrical cable of the umbilical prototype, with procedures and acceptance criteria defined in [1]:

- DC Conductor Resistance and
- Insulation Resistance

#### 6.3.4.4 Power Electrical Cables

The following tests shall be performed before and after the Prototype Qualification Test, for every power electrical cable of the umbilical prototype, with procedures and acceptance criteria defined in [6] (except for the Insulation Resistance at Ambient Temperature Test, see Note 4):

- Electrical Resistance of Conductors
- Partial Discharge
- Voltage
- Tan Delta Measurement<sup>1,2</sup> and
- Insulation Resistance at Ambient Temperature<sup>3,4</sup>

*Note 1:* due to temperature limitations, the Tan Delta Measurement before a prototype qualification test may be performed in a cable sample from the same cable spool used to manufacture the prototype sample. After a prototype qualification test, Tan Delta Measurement shall be performed on cable samples stripped from the aged umbilical prototype after dissection.

*Note 2:* there are no acceptance criteria for Tan Delta Measurement. Significant changes in the results may require cause investigations.

	TECHNICAL SPECIFICATION	No. I-ET-3000.00-1500-29B-PAZ-006	REV. B
	UMBILICAL SYSTEMS FOR SUBSEA APPLICATION		SHEET 27 of 28
	TITLE: QUALIFICATION FOR POWER, CONTROL AND INJECTION UMBILICALS		NP-1
			SUB/ES/DCT

*Note 3:* the Insulation Resistance at Ambient Temperature Test shall also be performed during Prototype Qualification Tests, at number of cycles stated on items 6.3.2.6 and 6.3.2.8 of section 6.3.2.

*Note 4:* the Insulation Resistance at Ambient Temperature Test Procedure is described below:

- 1) Clean up all three cable ends where the insulation tester probe will be fixed;
- 2) Electrically interconnect all three metallic screens and two cable cores;
- 3) Fix one probe of the insulation tester on the free cable core and the other probe on the other point electrically interconnected to the metallic screens and the other two cable cores;
- 4) Perform the test applying 5kV dc voltage during 10 minutes using an insulation tester capable to register the test current and the insulation resistance continuously through the test. Register also the ambient temperature. It shall be presented a graph current x insulation resistance x test time or a table with the values. It shall be marked the results for 30s, 1min e 10 min;
- 5) Perform the test again using the Guard Terminal to drain any surface current between the conductor under test and the metallic screen;
- 6) Repeat steps 1 to 5 for the other two cable cores in order to complete the insulation test of the phases against each other and the earth;
- 7) If any significant change in the results (more than +/- 30%) is detected, the causes must be evaluated.

#### **6.3.4.5 Fiber Optical Cable**

There is no required verification test for fiber optical cables before, during or after any Prototype Qualification Test. However, all the optic fibers must have the attenuation continuously monitored. For this monitoring, MANUFACTURER shall follow the Method A described in [7].

### **6.4 Tests Accomplishment**

A qualification test is considered successfully accomplished when the functional component or the umbilical prototype (together with the aged functional components) meets the defined acceptance criteria for the test (when applicable).

Whenever a qualification test fails, for any reason, MANUFACTURER shall inform PETROBRAS as soon as possible. If feasible, the prototype shall not be disassembled from the test rig and no further action shall be taken until MANUFACTURER and PETROBRAS come to an agreement on how to treat the event. MANUFACTURER shall present technical reasons for the test failure and, under PETROBRAS request, propose new parameters and/or a new methodology and/or a new product to carry a new test on. PETROBRAS reinforces the need of technically based arguments for the evaluation of the test failure and the acceptance of MANUFACTURER's proposal.

### **6.5 Qualification Reports**

#### **6.5.1 Functional Component Qualification Report**

MANUFACTURER shall issue a Qualification Report for each new functional component design that goes through a qualification process. This report shall comprise:

- functional component drawing and data sheet

	TECHNICAL SPECIFICATION	No. I-ET-3000.00-1500-29B-PAZ-006	REV. B
	UMBILICAL SYSTEMS FOR SUBSEA APPLICATION		SHEET 28 of 28
	TITLE:	QUALIFICATION FOR POWER, CONTROL AND INJECTION UMBILICALS	NP-1
			SUB/ES/DCT

- reference to followed PETROBRAS specifications and/or international standards
- reference to test procedures adopted to perform the Qualification Tests
- tests results, with acceptance criteria (when applicable)
- calibration certificates of all measuring devices used in the tests
- verification comments (*vercom's*) issued by the IVA

### 6.5.2 Prototype Qualification Report

Every Prototype Qualification Test is followed by the dispatch of a test report by the MANUFACTURER, with minimum content described on items from 6.3.2.1 to 6.3.2.8, for PETROBRAS evaluation.

After PETROBRAS approval on all test reports, MANUFACTURER shall issue a Qualification Report, compiling the following documents:

- prototype cross section drawing and data sheet
- reference to all functional components qualification reports
- reference to test procedures adopted to perform the Prototype Qualification Tests
- prototype qualification tests reports
- verification comments (*vercom's*) issued by the IVA

All remarkable events occurred during the course of the qualification process shall be included in the Prototype Qualification Report, such as test failures, for example.

### 6.6 Qualification Accomplishment

The functional component or the umbilical prototype is considered qualified after PETROBRAS approval on the respective Qualification Report.